

SHARP®



MODEL
AR-M208

DIGITAL MULTIFUNCTIONAL SYSTEM

KEY OPERATOR'S GUIDE

Page

- REGISTERING
THE KEY OPERATOR
CODE NUMBER 2
- LIST OF KEY OPERATOR
PROGRAMS 5
- USING THE KEY
OPERATOR PROGRAMS 7
- KEY OPERATOR
PROGRAMS 9

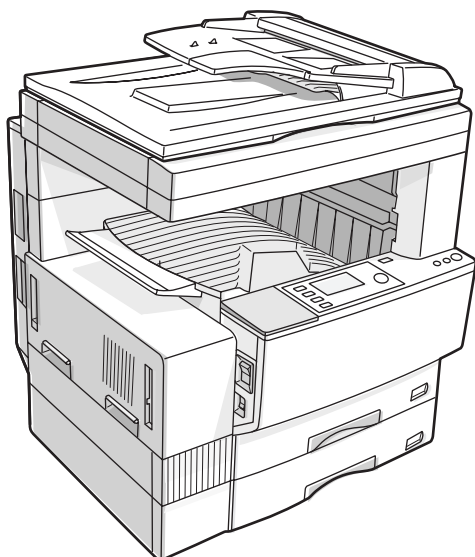

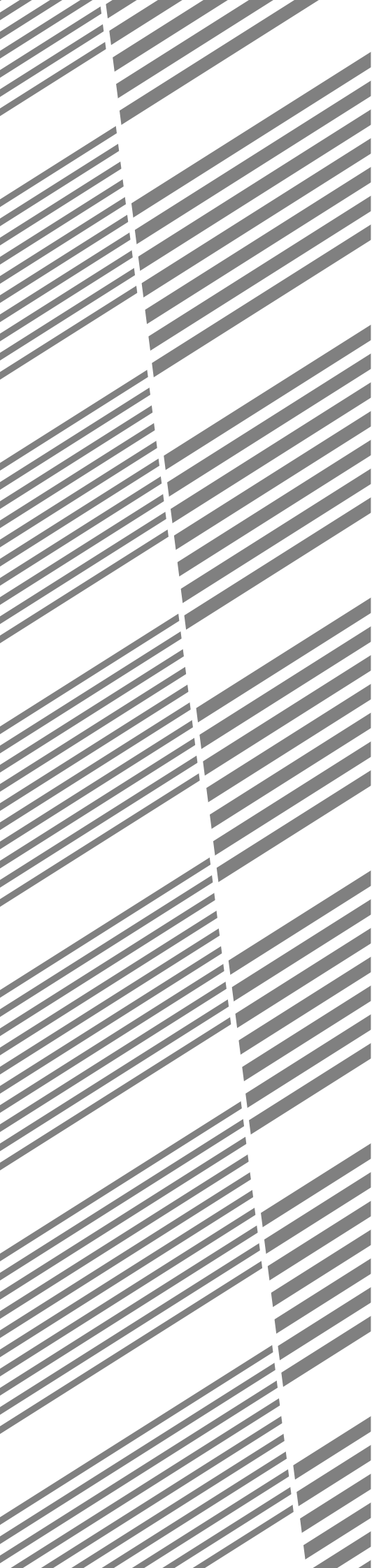

This KEY OPERATOR'S GUIDE contains information about all programs for use by the key operator. The programs allow the key operator to tailor many functions of this copier for specific modes of operation. These programs can only be accessed after a key operator code number has been entered.

Please familiarize yourself with this entire guide. Keep it handy, and refer to it for the information you need to keep the copier operating smoothly.

This guide describes the copier features. For description of the other features, see the separate relevant manuals.

CONTENTS

	Page
● REGISTERING THE KEY OPERATOR CODE NUMBER	2
● LIST OF KEY OPERATOR PROGRAMS	5
● USING THE KEY OPERATOR PROGRAMS	7
● KEY OPERATOR PROGRAMS	9
Function setting.	9
Timer setting.	13
Enable/disable	15
Account control.	17
Other program.	20

REGISTERING THE KEY OPERATOR CODE NUMBER

A key operator code number must be registered before any key operator program can be used. The key operator must remember this number. Only this registered number will allow access to the key operator programs.

1 Press the SPECIAL FUNCTION key.

- The SPECIAL FUNCTION screen will appear.

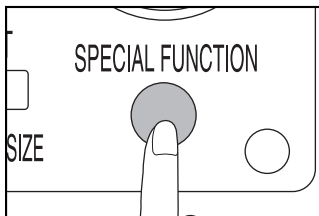

2 Use the ▲ and ▼ keys to select "KEY OPERATOR PRG." and press the OK key.

- The following display will appear.

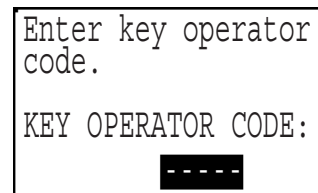
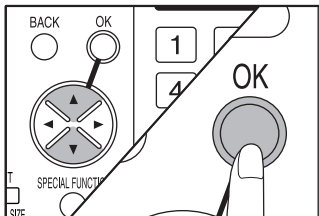

3 Enter 0 five times using the zero key.



- As the code number is entered, the dashes in the display will change to asterisks.
- The MODE SELECT screen will appear with COPIER highlighted.

4 Press the OK key.

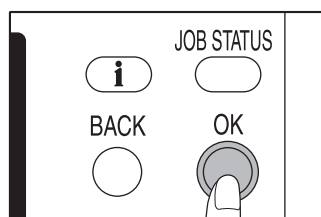

- The COPIER MODE screen will appear with FUNCTION SETTING highlighted.

5 Press the OK key.

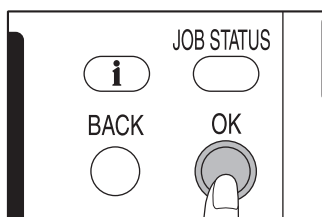

- The FUNCTION SETTING screen will appear with KEY OP. # CHANGE highlighted.

6 Press the OK key.

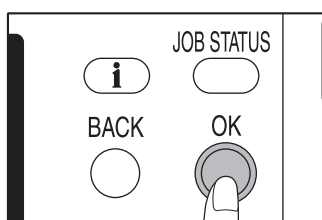

7 Choose a new 5-digit code number and enter it using the numeric keys.

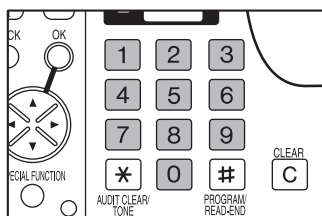

8 Press the OK key.

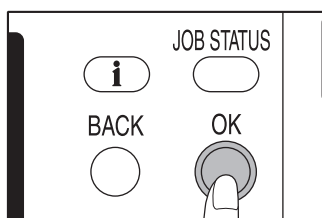

- The code number will change from the factory setting (five zeros) to the new setting. This new setting will remain in effect until it is changed by the procedure above. To change the number again, the current registered number must be used in step 3.

REGISTERING THE KEY OPERATOR CODE NUMBER

- 9** To continue with other key operator programs, use the ▲ and ▼ keys to select another program. To select a program of another category, press the BACK key and select the desired category. To exit the key operator program mode, press the CLEAR ALL (CA) key.

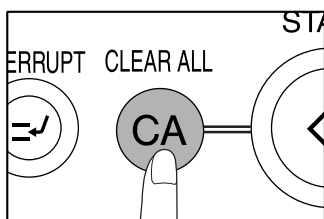

LIST OF KEY OPERATOR PROGRAMS

A complete list of all key operator programs is provided below. These programs can only be accessed by first entering the key operator code number.

Category	Program Name	Function	Page No.
Function setting	Key Operator Number Change	Changes the key operator code number.	9
	Exposure Adjust	Lightens or darkens copies in the automatic exposure mode.	9
	Margin Default	Sets the initial margin shift values.	9
	Erase Adjust	Sets the initial amount of the erase area.	10
	Stream Feeding	Enables the stream feeding mode for copying from a RSPF.	10
	Rotation Copy	Enables/disables rotation of original images.	10
	Output Trays	Sets the output trays for the copy and printer modes. (This program can be used only if an optional finisher or job separator tray kit is installed.)	11
	Offset Function	Enables/disables the offset function in the output tray.	11
	Memory for Printer	Sets the memory assignment used for printer feature.	12
	Toner Save Mode	Reduces toner consumption.	12
Timer setting	Auto Power Off	Sets a time interval after which the copier enters the auto power shut-off mode.	13
	Auto Clear	Sets a time interval after which the copier returns to the initial settings.	13
	Preheat Mode	Sets the time that elapses before the copier enters the preheat mode after copying is completed.	14
	Time Out Setting	Sets the time after which a print or fax job resumes. (This program can be used only if an optional facsimile expansion kit is installed.)	14

LIST OF KEY OPERATOR PROGRAMS

Category	Program Name	Function	Page No.
Enable/disable	Disable Auto Paper Selection	Prevents automatic paper selection.	15
	Disable Auto Tray Switching	Prevents automatic switching between the paper trays.	15
	Disable Job Program Changing	Prevents stored programs from being replaced or deleted.	15
	Disable Center Tray Counting	Disables count of paper output into the copier center tray.	15
	Disable Auto Power Shut-off	Disables the auto power shut-off mode.	16
	Disable Beep at Key Touch	Enables or disables sounding of beep when keys are touched.	16
	Disable Backlight Change	Disables change of the liquid crystal display (LCD) backlighting color.	16
Account control	Auditing Mode	Enables or disables the basic auditing mode, which controls access to copier.	17
	Copies per Account	Displays the total number of copies made against account numbers.	17
	Reset Account	Resets all audit accounts or selectively resets individual accounts.	18
	Account Number Control	Registers accounts, deletes accounts or changes an account number.	18
	Account Number Security	Guards against trial and error entering of audit account numbers.	19
Other program	Total Count	Recalls the total counts, including counts of the copier, RSPF, duplex module, stapler, and the printing counts.	20

USING THE KEY OPERATOR PROGRAMS

1 Press the SPECIAL FUNCTION key.

- The SPECIAL FUNCTION screen will appear.

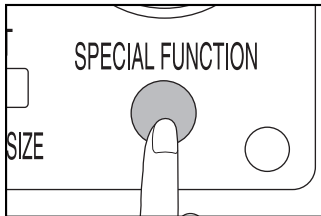

2 Use the ▲ and ▼ keys to select "KEY OPERATOR PRG." and press the OK key.

- The following display will appear.

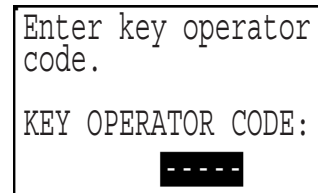
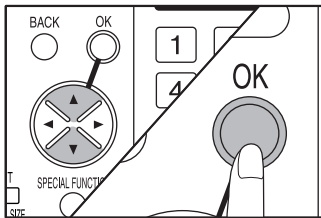

3 Enter the key operator code number.

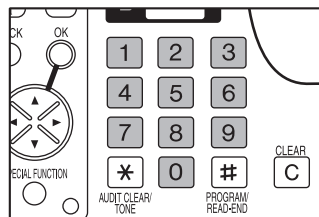

- The dashes in the display will change to asterisks.
- The MODE SELECT screen will appear with COPIER highlighted.

4 Press the OK key.

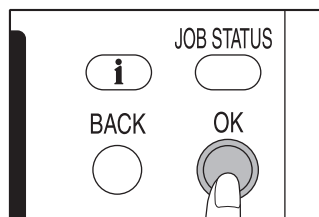

- The COPIER MODE screen will appear.

USING THE KEY OPERATOR PROGRAMS

- 5** Use the ▲ and ▼ keys to select the desired category and press the OK key.

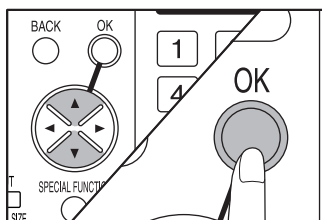

- Example: To see the number of copies per account, select "ACCOUNT CONTROL".

- 6** Use the ▲ and ▼ keys to select the desired program and press the OK key.

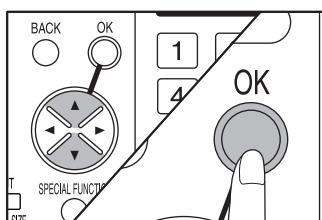

- Example: To see the number of copies per account, select "COPIES/ACCOUNT".
- For some programs, a check box is displayed to the left of the program name. If the OK key is pressed, a check mark will appear and the program will be set. If the OK key is pressed again, the check mark will disappear and the program will be canceled. Proceed to step 8.
- For other programs, the setting screen of the program will appear when the OK key is pressed.

- 7** Follow instructions for the program.

- 8** To continue with other key operator programs, use the ▲ and ▼ keys to select another program. To select a program of another category, press the BACK key and select the desired category. To exit the key operator program mode, press the CLEAR ALL (CA) key.

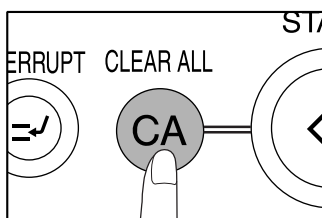

KEY OPERATOR PROGRAMS

FUNCTION SETTING

The programs of this category are used to adjust various settings of copier functions. These programs can be selected by using the ▲ and ▼ keys to highlight "FUNCTION SETTING", pressing the OK key, highlighting the desired program, and then pressing the OK key.

Key Operator Number Change

See page 2, REGISTERING THE KEY OPERATOR CODE NUMBER.

Exposure Adjust

Use this program to lighten or darken copies in the automatic exposure mode. The exposure level can be set for copying from the platen glass or copying from either a RSPF. The factory setting is level 3. When "EXPOSURE ADJUST" is selected and the OK key is pressed, the following display will appear.

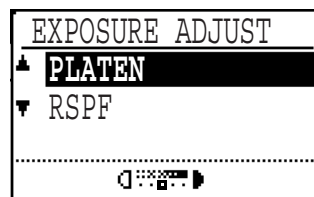

1. Use the ▲ and ▼ keys to select the "PLATEN" (platen glass) or "RSPF".
2. Adjust the exposure using the ◀ and ▶ keys.
3. Repeat steps 1 and 2 to adjust the other exposure level.
4. Press the OK key.

Margin Default

Set the initial margin shift value with this program.

When "MARGIN DEFAULT" is selected and the OK key is pressed, the following display will appear.

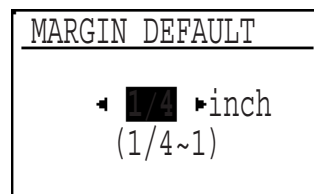

1. Adjust the initial margin shift value using the ◀ and ▶ keys.
 - The value can be set from 1/4" to 1" in 1/4" increments.
2. Press the OK key.

Erase Adjust

Set the initial setting of the amount of the erase area with this program.

When "ERASE ADJUST" is selected and the OK key is pressed, the following display will appear.

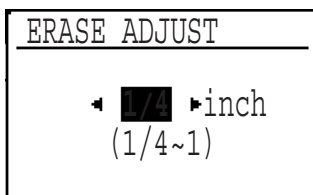

1. **Adjust the value for the edge erase mode and center erase mode using the ◀ and ▶ keys.**
 - The value can be set from 1/4" to 1" in 1/4" increments.
2. **Press the OK key.**

Stream Feeding

This program is used to enable the stream feeding mode of a RSPF. When the stream feeding mode is enabled, additional originals which are set in the document feeder tray within 5 seconds after the previous original was fed will be fed and copied automatically.

To enable the stream feeding mode, highlight "STREAM FEEDING" and press the OK key to display a check mark in the check box.

To disable this function, select this program and press the OK key again to clear the check mark in the check box.

Rotation Copy

If this program is set, the image of originals will rotate when the orientation of the originals does not match that of the copy paper.

Rotation copy will function only when the auto paper select or auto image mode has been selected.

NOTE:

If the image is rotated in reduction copying, the position of the image in relation to copy paper will vary with the orientations of the originals and copy paper.

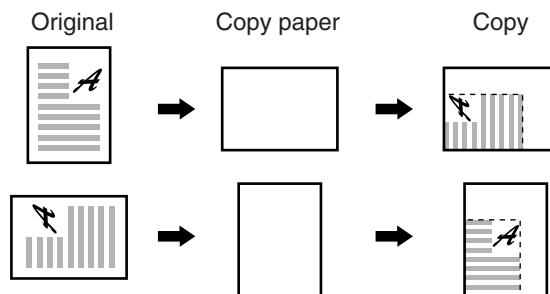

To enable rotation copy, highlight "ROTATION COPY" and press the OK key to display a check mark in the check box.

To disable this mode, select this program and press the OK key again to clear the check mark in the check box.

Output Trays

If a job separator tray kit or a finisher is installed along with a facsimile expansion kit, this program can be used to specify which output tray will be used to receive copies and which will be used to receive prints.

When "OUTPUT TRAYS" is selected and the OK key is pressed, the following display will appear. (Example: The following display is shown for a copier equipped with a facsimile expansion kit, and a job separator tray kit.)

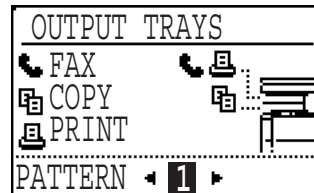

1. Use the ◀ and ▶ keys to select the desired pattern of output trays.
2. Press the OK key.

Offset Function

If the offset function is enabled, each set of copies will be stacked offset from the previous set in the sort and group modes in the center tray of the copier or in the offset tray of a finisher. This program is used to enable or disable the offset function for these trays respectively.

When "OFFSET FUNCTION" is selected and the OK key is pressed, the following display will appear.



1. Use the ◀ or ▶ key to enable or disable the offset function for the center tray of the copier.
2. If a finisher is installed, use the ▼ key to select "OFFSET TRAY" and use the ◀ or ▶ key to enable or disable the offset function for the offset tray of the finisher.
3. Press the OK key.

Memory for Printer

This copier has a memory for storing data of scanned originals. Part of this memory will be used for storing print data. This program is used to set the percentage of the memory used for the printer feature. The default setting is 50%.

When "MEM. FOR PRINTER" is selected and the OK key is pressed, the following display will appear.

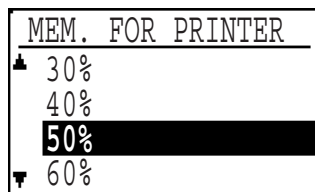

1. Use the ▲ and ▼ keys to select the desired percentage.
2. Press the OK key.

NOTE:

The memory capacity for storing original images and print data is 16 MB. The memory can be extended to a maximum of 272 MB by adding commercially available memory modules.

Toner Save Mode

The toner save mode will reduce toner consumption by approximately 10% in the automatic, text, and text/photo exposure modes. Copies will be lighter but still adequate for general use. Selection of this mode has no effect on the photo mode.

To turn on the toner save mode, highlight "TONER SAVE MODE" and press the OK key to display a check mark in the check box.

To turn off the toner save mode, select this program and press the OK key again to clear the check mark in the check box.

TIMER SETTING

The programs of this category are used to set the timers for some functions. These programs can be selected by using the ▲ and ▼ keys to highlight "TIMER SETTING", pressing the OK key, highlighting the desired program, and then pressing the OK key.

Auto Power Off

The auto power shut-off mode is a function to turn off the power to the fuser automatically once a programmed length of time has elapsed without any copier operation after the last copy of a run is made or power is turned on.

This function will help lower the user's electricity bill, reduce waste of natural resources, and cut down on environmental pollution.

The programmed time is set to 60 minutes for this function as shipped from the factory. The default time can be changed optionally within the prescribed range of time. We suggest you set the most appropriate time according to your usage pattern.

The time until auto power shut-off occurs can be set to 10, 30, 60, 90, 120 or 240 minutes.

When "AUTO POWER OFF" is selected and the OK key is pressed, the following display will appear.

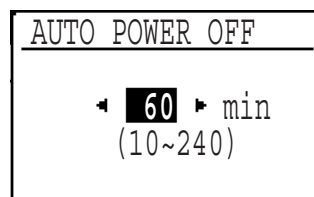

1. Select the desired time interval using the ◀ and ▶ keys.
2. Press the OK key.

Auto Clear

Use this program to set the time interval to return the copier to the initial settings after the last copy of a run has been completed. The time can be set to 0, 30, 60, 90, 120 or 240 seconds. The factory setting is 60 seconds.

When "AUTO CLEAR" is selected and the OK key is pressed, the following display will appear.

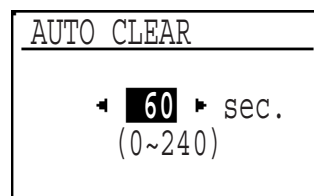

1. Select the desired time interval using the ◀ and ▶ keys.
 - To disable the auto clear, select 0.
2. Press the OK key.

Preheat Mode

Preheat mode functions to reduce the power consumption by lowering the temperature of the fusing unit to a programmed level once a programmed length of time has elapsed without any copier operation after the last copy of a run is made or power is turned on. The preheat mode will help lower the user's electricity bill, reduce waste of natural resources, and cut down on environmental pollution. The programmed time is set to the factory default of 15 minutes as shipped from the factory. The default time can be changed optionally within the prescribed range of time. We suggest you set the most appropriate time according to your usage pattern.

The interval can be set to 1, 2, 5, 10, 15, 30, 60, 120 or 240 minutes.

When "PREHEAT MODE" is selected and the OK key is pressed, the following display will appear.

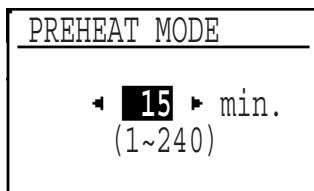

1. Select the desired time interval using the ◀ and ▶ keys.
2. Press the OK key.

Time Out Setting

If a copy job is started while a print or fax job is being run, the print or fax job will be interrupted. This program is used to adjust the time that elapses before the print or fax job resumes after the copy job is completed. If a print or fax job is sent to this machine while a copy job is being run, printing of the print or fax job will start when the programmed time elapses after the copy job is completed. The time can be set to 0, 10, 30 or 60 seconds. If 0 is set, the print or fax job will resume immediately after a copy run has finished. (A facsimile expansion kit must be installed to run a fax job.)

When "TIME OUT SETTING" is selected and the OK key is pressed, the following display will appear.

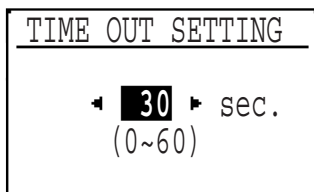

1. Select the desired time using the ◀ and ▶ keys.
2. Press the OK key.

ENABLE/DISABLE

The programs of this category are used to enable or disable some functions. These programs can be set or canceled by using the ▲ and ▼ keys to highlight "ENABLE/DISABLE", pressing the OK key, highlighting the desired program, and then pressing the OK key.

Disable Auto Paper Selection

This program is used to prevent automatic paper selection. When disabled, the copier will not automatically select a paper tray containing paper that matches the size of the original placed on the platen glass or in a RSPF.

To disable auto paper selection, highlight "DISABLE AUTO PAPER SELECTION" and press the OK key to display a check mark in the check box.

To restore this function, select this program and press the OK key again to clear the check mark in the check box.

Disable Auto Tray Switching

This program prevents automatic switching between the paper trays. If automatic tray switching is enabled, when paper runs out during copying, any tray with paper of the same size in the same orientation will be automatically selected and copying will continue.

To disable auto tray switching, highlight "DISABLE AUTO TRAY SWITCHING" and press the OK key to display a check mark in the check box.

To restore this function, select this program and press the OK key again to clear the check mark in the check box.

Disable Job Program Changing

This program is used to prevent stored programs from being replaced or deleted. If this program is set, storing of job programs is also disabled.

To prevent job programs stored in memory from being replaced or deleted, highlight "DISABLE JOB PRG. CHANGING" and press the OK key to display a check mark in the check box.

To allow replacement/deletion, select this program and press the OK key again to clear the check mark in the check box.

Disable Center Tray Counting

In the default setting, when copies or printed sheets are delivered to the center tray of the copier, the number of sheets delivered will be counted. When counting is enabled, the copier will automatically stop when the count has reached the limit. This program can be used to disable counting in the center tray of the copier.

To disable counting, highlight "DISABLE CENTER TRAY COUNTING" and press the OK key to display a check mark in the check box.

To enable counting, select this program and press the OK key again to clear the check mark in the check box.

Disable Auto Power Shut-off

The auto power shut-off mode is used to turn off the power to the fuser automatically once a programmed length of time has elapsed without any copier operation after the last copy of a run is made or power is turned on. This mode lowers the user's electricity bill, reduces waste of natural resources, and cuts down on environmental pollution.

Depending on how the machine is to be used, you may wish for some reasons to disable this mode. This can be done using this program.

NOTE:

Since we would like you to fully understand the purpose of this mode, we suggest that you enable this mode and set the most appropriate time using program "AUTO POWER OFF" (page 13).

To disable the auto power shut-off mode, highlight "DISABLE AUTO POWER SHUT-OFF" and press the OK key to display a check mark in the check box.

To restore the mode, select this program and press the OK key again to clear the check mark in the check box.

Disable Beep at Key Touch

This program is used to enable or disable the beep function. If this function is enabled, a beep sound will be produced when you press a key on the operation panel.

To disable the beep function, highlight "DISABLE BEEP AT KEY TOUCH" and press the OK key to display a check mark in the check box.

To enable the beep function, select this program and press the OK key again to clear the check mark in the check box.

Disable Backlight Change

If backlight color change is enabled, the color of the backlighting of the display varies with the copier status as shown below:

Green: Normal

Yellow: Toner is low or maintenance will be needed soon

Orange: The copier cannot operate because of a misfeed, no toner or some other malfunction.

This program is used to disable the function that changes backlighting color. (Backlight color change is disabled in the factory default setting.)

To disable change of the backlight color, highlight "DISABLE BACKLIGHT CHANGE" and press the OK key to display a check mark in the check box.

To enable the function, select this program and press the OK key again to clear the check mark in the check box.

ACCOUNT CONTROL

The programs of this category are used to set the internal auditor functions. These programs can be selected by using the ▲ and ▼ keys to highlight "ACCOUNT CONTROL", pressing the OK key, highlighting the desired program, and then pressing the OK key.

Auditing Mode

This program is used to enable or disable the basic auditing mode.

When enabled, the message in the display will be "Enter your account number." Copying in this state is limited to operators with an assigned 5-digit account number.

When disabled, the message in the display will be "Ready to copy." Access to copying is open to any operator.

A maximum of 50, 5-digit account numbers can be assigned. Use key operator program "Account Number Control" (page 18) to assign account numbers.

To enable the auditing mode, highlight "AUDITING MODE" and press the OK key to display a check mark in the check box.

To disable the auditing mode, select this program and press the OK key again to clear the check mark in the check box.

Copies per Account

This program is used to display the total number of copies made against each account number.

An 11" x 17" copy is counted as two copies. A two-sided copy is also counted as two copies.

When "COPIES/ACCOUNT" is selected and the OK key is pressed, the following display will appear.

COPIES/ACCOUNT	
▲	ACCOUNT #:18114
	PRINTS 001,100
	COPIES 003,456
▼	COPY LIMIT 600,000

- 1. Press the ▼ key to advance through the accounts.**

 - The number of copies made the number of prints made, and the maximum allowable number of copies per account will be displayed.
 - If "---,---" is displayed for COPY LIMIT, no account limit has been set for the account.
 - Account data is displayed in ascending order of account number.
- 2. Press the OK key.**

Reset Account

This program is used to reset all audit accounts or to selectively reset individual accounts. When "RESET ACCOUNT" is selected and the OK key is pressed, the following display will appear.

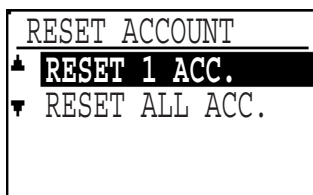

To reset all accounts

1. Use the ▲ and ▼ keys to select "RESET ALL ACC." and press the OK key.
2. Use the ▲ and ▼ keys to select "YES" and press the OK key.

To reset a single account

1. Use the ▲ and ▼ keys to select "RESET 1 ACC." and press the OK key.
2. Use the ▲ and ▼ keys to select an account to be reset and press the OK key.
 - If "000,000" is displayed for COPY LIMIT, no account limit has been set for the account.
3. Use the ▲ and ▼ keys to select "YES" and press the OK key.
4. Continue with steps 2 and 3 for other account numbers. Press the BACK key repeatedly to exit the program.

Account Number Control

This program is used to register accounts, delete accounts or change an account number. When "ACC. # CONTROL" is selected and the OK key is pressed, the following display will appear.

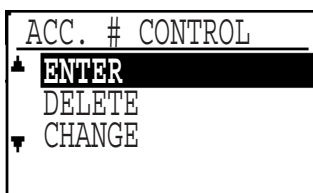

To register accounts

1. Use the ▲ and ▼ keys to select "ENTER" and press the OK key.
 - If 50 accounts have already been registered, the message "The account register is full. 50 is maximum." will appear.
2. Enter a 5-digit account number (00000 to 99999) using the numeric keys.
 - Select a number different from the key operator code number.
3. Press the OK key.
 - If a number that is already registered is entered, the message "This number is already used. Enter another number." will appear.
4. To enter other account numbers, repeat steps 2 and 3. Press the BACK key repeatedly to exit the program.

To delete accounts

1. Use the ▲ and ▼ keys to select "DELETE" and press the OK key.
2. To delete all accounts, use the ▲ and ▼ keys to select "DELETE ALL ACC." and press the OK key.
 - A message will appear to confirm the selection. Use the ▲ and ▼ keys to select "YES" and press the OK key to delete all accounts. If you decide not to delete all accounts, select "NO" and press the OK key.
3. To delete an individual account, use the ▲ and ▼ keys to select "DELETE 1 ACC." and press the OK key.
4. Enter the account number to be deleted using the numeric keys and press the OK key.
5. Use the ▲ and ▼ keys to select "YES" and press the OK key.
 - If a number that has not been registered is entered, the display will return to the account number entry screen.
6. To delete other account numbers, repeat steps 4 and 5. Press the BACK key repeatedly to exit the program.

To change an account number

1. Use the ▲ and ▼ keys to select "CHANGE" and press the OK key.
2. Enter the account number to be changed using the numeric keys.
3. Enter a new account number.
4. Press the OK key.
 - If a number that is already registered is entered, the message "This number is already used. Enter another number." will appear.
5. To change other account numbers, repeat steps 2 to 4. Press the BACK key repeatedly to exit the program.

NOTES:

- When entering an account number, be sure to input five digits. If not, the OK key will not be accepted.
- If you press the CLEAR (C) key when entering an account number, the account number display will change to "-----".

Account Number Security

This program is used to make it difficult for users to gain access to accounts by entering code numbers through trial and error. If this program is selected and an operator enters three successive invalid account numbers, the copier will not accept another number for one minute and the message "Please see your key operator for assistance." will appear.

To enable the account number security function, highlight "ACC. # SECURITY" and press the OK key to display a check mark in the check box.

To disable this function, select this program and press the OK key again to clear the check mark in the check box.

OTHER PROGRAM

Total Count

This program can be selected by using the ▲ and ▼ keys after the key operator program mode is entered.

This program is used to display the total counts, including counts of the copier, RSPF, duplex module, stapler and the printing counts. Also, facsimile, and scanning counts will be displayed if the relevant features are installed.

An 11" x 17" sheet is counted as two sheets. A two-sided copy is also counted as two sheets.

The sheets printed with the self-print function of the printer, facsimile, and scanner features are included in "OTHERS".

When "TOTAL COUNT" is selected and the OK key is pressed, the following display will appear.

TOTAL COUNT	
▲COPIES	:000,155
RSPF	:000,050
DUPLEX	:000,013
▼STAPLER	:000,000

The total counts for all units in use will be displayed.

Press the OK key to exit the program.

SHARP[®]

SHARP ELECTRONICS CORPORATION

Sharp Plaza, Mahwah, New Jersey 07430-2135.

www.sharp-usa.com

SHARP CORPORATION